

HOSTED BY



ELSEVIER

Contents lists available at ScienceDirect

# Engineering Science and Technology, an International Journal

journal homepage: [www.elsevier.com/locate/jestch](http://www.elsevier.com/locate/jestch)

Full Length Article

## Precise torque control for interior mounted permanent magnet synchronous motors with recursive least squares algorithm based parameter estimations



Mikail Koç\*, Osman Emre Özçiflikçi

Kirsehir Ahi Evran University, Department of Electrical and Electronics Engineering, Kirsehir 40100, Turkey

## ARTICLE INFO

## Article history:

Received 9 July 2021

Revised 8 October 2021

Accepted 16 December 2021

Available online 25 January 2022

## Keywords:

IPM drives

MTPA

RLS

Parameter estimation

Electric vehicles

## ABSTRACT

Interior mounted permanent magnet (IPM) machines have superior features comparing to their counterparts for electric vehicle traction applications. Having relatively higher efficiency, high torque and power densities, low torque ripple and not requirement of regular maintenance are among their superior features. It is widely known that the precise torque control in practical IPM drives highly relies on accurate knowledge of machine parameters viz, inductance values and magnetic flux linkage. These machine parameters vary significantly in real time operation depending on manufacturing tolerance, operating temperature, inductance saturation, load torque and so on. It is known that d- and q- axis inductances and magnetic flux linkage at the full load operation may be approximately 20%, 35% and 20%, respectively, lower than their actual values at no-load operation. It is also commonly known in the literature for traction applications that these variations (considering wide range operation) have much influence on both drive system efficiency and output torque production compared to other system nonlinearities such as stator resistance variation. It has been achieved in this paper that these parameters are estimated online with fairly high accuracies of each, utilizing recursive least squares (RLS) algorithm. The superiority of the proposed drive achieving considerably higher output torque (~28,7% of peak torque) is validated through extensive realistic simulations with nonlinear machine model of a 4.1 kW prototype IPM machine designed and manufactured for traction applications. Proposed strategy and its superiority among state-of-art drives are discussed in detail.

© 2021 Karabuk University. Publishing services by Elsevier B.V. This is an open access article under the CC BY-NC-ND license (<http://creativecommons.org/licenses/by-nc-nd/4.0/>).

### 1. Introduction

Utilization of renewable and sustainable energy technologies plays an important role to deal with worldwide environmental issues such as global warming [1]. Transportation is one of the dominant sectors in which non-renewable energy sources are consumed. It is possible to alleviate the environmental issues that raises from the use of conventional internal combustion engine-based vehicles for transportation by replacing them with electric vehicles which facilitate the use of renewable and sustainable energy technologies with no carbon emissions [2,3].

Interior mounted permanent magnet synchronous machines (IPMSM) are commonly employed in electric vehicles due to their superior features such as high power-density, small volume, high efficiency, high torque-density and so on. Precise torque control

in IPM drives with improved output torque production quality is, therefore, quite significant research area for wide societies.

It is widely known in the literature that magnetic flux linkage based torque component is maximum when current angle is zero ( $\beta = 0^\circ$  in Fig. 1) and reluctance torque component is maximum when  $\beta = 45^\circ$ . While maximum torque production, and hence maximum efficiency operation in constant torque region, can be achieved when  $\beta = 0^\circ$  in surface mounted permanent magnet machine (SPM) drives as they have no reluctance torque component, the saliency in IPM drives facilitates the benefit from reluctance torque component by varying the  $\beta$  angle online and this renders them higher efficient and attractive machines. Hence, obtaining and operating at the optimum  $\beta$  angle in IPM drives is crucial for precise torque control and efficiency optimized operation in constant torque region.

Theoretically, the  $\beta$  angle is a function of dq- axis inductances ( $L_{dq}$ ), permanent magnet flux linkage ( $\Psi_m$ ), stator current magnitude ( $I_s$ ) and the demanded electromagnetic torque ( $T_e$ ) from the machine [4]. Hence, it is evident that precise torque control and

\* Corresponding author.

E-mail address: [mkok@ahievran.edu.tr](mailto:mkok@ahievran.edu.tr) (M. Koç).

Peer review under responsibility of Karabuk University.

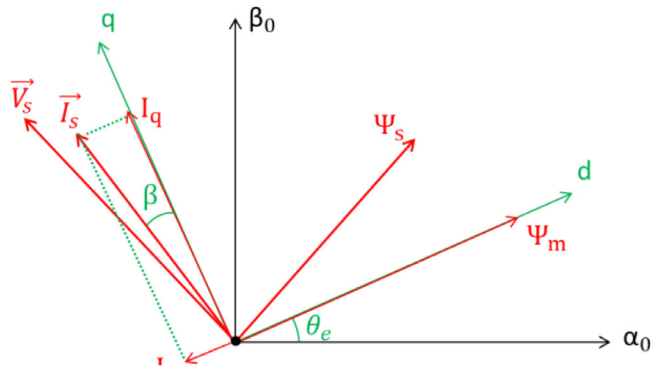

Fig. 1. Current, voltage and stator flux vectors in stationary and rotating frames.

the efficiency optimized operation can be achieved with accurate knowledge of machine parameters. In practical applications, however, these parameters may significantly deviate from their nominal values depending on magnetic saturations, operating temperature, manufacture tolerance, cross-coupling, material property variations and so on. Based on high-fidelity machine modelling in [5], it is evident that d- and q- axis inductance values and the value of magnetic flux linkage at peak current operation may approximately 20%, 35% and 20% lower than that of machine parameters at no-load operation. Hence, driving machines by employing constant machine parameters in the controller as in [6] cannot achieve optimized control in practice. Thus, estimation of the varying parameters with high accuracy facilitates to drive the machine with higher efficiency and higher output torque production in practical applications.

In the literature, the parameter variations can be addressed utilizing either *online* or *offline* strategies both having the pros and cons [7,8]. *Offline strategies* based on experiments require many prior tests at different operating points such as at different current magnitudes. Varying operating conditions should also be considered for more accurate results. For example, an accurate offline strategy at a certain operating temperature may remarkably deviate from those obtained at a different temperature. One can consider the temperature variations by measuring it, however, the temperature inside the machine is not uniformly distributed and the magnets' temperature may significantly deviate from the measured stator temperature. In addition, even high-fidelity machine modelling considering extensive operating conditions may remarkably lose its fidelity in few years of time as the machine wears out. Besides, the offline strategies require enough memory in the processor to be stored as look-up tables. In addition to all above, offline strategies are unique for a certain machine and all the procedures need to be undertaken for another machine even if the machine types are the same.

*Online strategies* for parameter estimations, on the other hand, can be adopted to other machines. Besides, online strategies handle the operating condition variations instantaneously, and hence, prior tests considering different conditions are not essential. Although increased computational burden on the processor may be considered as a drawback, there is a trade-off between the processor burden and the system efficiency as well as the precise torque control. Considering all, online parameter estimation strategies are quite common in the literature for efficiency optimized machine drives.

Model Reference Adaptive System (MRAS) [9–11], Extended Kalman Filter (EKF) [12], Affine Projection Algorithm (APA) [13], and Recursive Least Square (RLS) [14–16] algorithm based strategies are extensively utilized for online parameter estimations in the literature.

MRAS based parameter estimation, among them, is a challenge for multi-parameter identification [17,18]. d- axis inductance, for example, has been assumed as a constant in [9]. Similarly, magnetic flux linkage variation has been addressed in [11], however, variations in d- and q- axis inductances have significant influence in IPM drives. Multi-parameter estimation has been proposed employing MRAS based strategy, however, the system lacks the stability and is not feasible in practice [8].

EKF based online parameter estimation strategy has been proposed in [12]. However, dq- axis inductance variations have not been handled. Also, the computational burden in EKF based drives increases considerably as the order of the system increases due to inverse matrix calculation [8].

The authors in [13] obtains dq- axis inductance variations using APA strategy and the magnetic flux linkage variation is handled by steepest descent method. The combination of two different strategies not only increases the burden on the processor but increases the complexity and hence the implementation difficulty.

RLS algorithm based parameter estimations in [14,15,19] does not consider the variations in the magnetic flux linkage. The authors in [20] utilizes the RLS algorithm to estimate only the magnetic flux linkage and the stator resistance whereas the nonlinearities in inductances may significantly deteriorate the system performance. Each nonlinear parameters have been estimated utilizing RLS algorithm in [21]. The authors have adopted two different (fast and slow) RLS algorithms with different execution rates to sort the rank-deficiency issue. However, the results are of concern as the estimation is rather slow and the estimated parameters have much fluctuations.

Recently, magnetic flux linkage and dq- axis inductance variations are handled employing RLS algorithm in a model predictive control (MPC) based drive by Tinazzi *et al.* [16]. MPC based drives are much more vulnerable to machine parameter variations than the PI controllers-based drives as the MPC relies on machine models. Though the parameters are estimated in the proposed strategy, the drive have the following concerns. First, the inverter switching frequency is variable. However, it is widely known in the literature that the constant switching based space-vector PWM strategy is superior to its counterparts due to less harmonics and less torque ripples [22]. More importantly, authors indicate that parameter-free predictive control has been achieved. The claim would be true only when the system input is current command. It is, however, important to note that the system input is either electromagnetic torque or speed command in most practical applications. The generation of the current commands relies on machine parameters in [16], and hence, it is indeed parameter dependent drive. Similarly, the system input of RLS algorithm based drives in [23,24] is current command rather than torque or speed.

This paper discusses the recent modern drives in literature and proposes a novel IPM machine drive addressing the above-mentioned issues appertaining to state-of-art control strategies. Variations of the nonlinear dq- axis inductances and the permanent magnet flux linkage are estimated online utilizing RLS algorithm. High accuracy in estimations for each parameter have been achieved. Precise torque control has been obtained owing to employment of the estimated parameters to generate current commands in the controller. Besides, decoupling compensation has been adopted with the estimated parameters. By doing so, the transient performance of the drive system has been improved as well. The proposed drive achieves constant switching frequency based operation and hence the increased torque and current ripple due to variable switching frequency based operation is avoided. The system input is torque command and the commanded dq- axis currents are generated by the utilization of the estimated parameters with high accuracy. The superiority of the proposed drive has

been validated through extensive simulations employing nonlinear machine models which represent parameter variations.

## 2. Mathematical modelling of IPM machines

Clark and Park transformations of ABC frame equations give dq-axis rotating reference frame modelling of AC machines. The well-known peak convention modelling of IPM machines in the rotor reference frame are given as follows:

$$\begin{bmatrix} V_d \\ V_q \end{bmatrix} = R \begin{bmatrix} I_d \\ I_q \end{bmatrix} + \frac{d}{dt} \begin{bmatrix} \Psi_d \\ \Psi_q \end{bmatrix} + \omega \begin{bmatrix} -\Psi_q \\ \Psi_d \end{bmatrix} \quad (1)$$

$$\begin{bmatrix} \Psi_d \\ \Psi_q \end{bmatrix} = \begin{bmatrix} L_d & 0 \\ 0 & L_q \end{bmatrix} \begin{bmatrix} I_d \\ I_q \end{bmatrix} + \begin{bmatrix} \Psi_m \\ 0 \end{bmatrix} \quad (2)$$

$$T_e = \frac{3p}{2} (\Psi_m I_q - I_d I_q (L_q - L_d)) \quad (3)$$

where  $I_{dq}$ ,  $V_{dq}$ ,  $\Psi_{dq}$  are the rotor frame currents (A), voltages (V) and flux linkages (Wb), respectively.  $\Psi_m$  is the permanent magnet flux linkage (Wb),  $p$  is number of pole-pairs,  $R$  is the phase resistance ( $\Omega$ ),  $\omega$  is electrical angular speed (rad/s),  $T_e$  is the electromagnetic torque (Nm) and  $L_{dq}$  are the dq-axis inductances (H), respectively. The optimum  $\beta$  angle shown in Fig. 1 is obtained by posing  $\partial T_e / \partial \beta$  to zero. The  $\beta$  angle is obtained under the assumption that partial derivatives of machine parameters with respect to current angle is zero.

$$\beta = \sin^{-1} \left( \left( -\Psi_m + \sqrt{\Psi_m^2 + 8(L_q - L_d)^2 I_s^2} \right) * (4(L_q - L_d) I_s)^{-1} \right) \quad (4)$$

## 3. Proposed drive system setup with parameter identification

It is known in the literature that the efficiency slightly deviates from the optimum point in real-life experiments in which the  $\beta$  angle is obtained utilizing (4). This is because the machine parameters vary with  $\beta$  angle in practice [25]. However, precise torque control can be achieved if the parameter variations in (4) can be addressed accurately. In other words, there will be gap between the demanded and the actual torque when actual machine parameters vary from those employed in (4). Similarly, the efficiency deviation from the optimized point may increase. Reduced efficiency deviation and closing the torque gap can be achieved by accurately estimating and employing the machine parameters in (4). Thus, the parameters are estimated by the RLS algorithm in the proposed drive and the precise torque control is achieved.

Schematic block diagram of the proposed system is illustrated in Fig. 2. The current errors are driven to zero via two PI controllers and the coupling terms in the machine model in (1) is compensated by decoupling in the controller as shown in Fig. 2. Estimated parameters are employed in (2) for decoupling compensation. The generated command voltages in rotating dq-frame is transformed into the stationary  $\alpha\beta$  frame before being fed into the SVPWM strategy. Circle limit strategy is employed to avoid over-modulation. Thus, the drive does not demand the voltage magnitude higher than the available DC link voltage and the operation remains in the linear region. Accurate position angle is obtained in the proposed drive and employed in the coordinate transformations similar to drives with an encoder or a position resolver. Details of the parameter identification strategy shown in Fig. 2 will be discussed in the next section and the details of the current command approximation from torque command can be found in [4].

## 4. Online parameter estimation strategy based on recursive least squares algorithm

Based on high-fidelity machine modelling in [5], it is known that actual  $L_d$ ,  $L_q$  and  $\Psi_m$  parameters of IPM machines at the full load operation may be roughly  $\sim 20\%$ ,  $\sim 35\%$  and  $\sim 20\%$  (respectively) lower than their accurate values at no-load operation [26]. RLS algorithm is commonly used in practical applications for nonlinear system identification. Hence, the nonlinear  $L_d$ ,  $L_q$  and  $\Psi_m$  parameters in the proposed drive will be estimated online through Recursive Least Squares Algorithm.

### 4.1. Generic expression of RLS

The standard technique consists of the following equations which are solved recursively [16].

$$K = \frac{P(n)\varnothing^T}{\varnothing^T P(n)\varnothing + I\lambda} \quad (5)$$

$$\hat{\theta}(n+1) = \hat{\theta}(n) + K(Y - \varnothing^T \hat{\theta}(n)) \quad (6)$$

$$P(n+1) = (I - K\varnothing)P(n)/\lambda \quad (7)$$

where  $\theta$  is unknown parameter vector,  $\varnothing$  is regressor vector,  $Y$  is output vector,  $K$  is Kalman gain,  $P$  is covariance matrix,  $I$  is identity matrix and  $\lambda$  is forgetting factor (FF). Fundamental theory associated with the generic expression is discussed in [16].

### 4.2. Implementation strategy in the proposed drive

Firstly, it is assumed that the model is expressed as;

$$Y = \hat{\theta} \varnothing \quad (8)$$

where the unknown parameter vector  $\theta$  consists of the nonlinear parameters which will be estimated.

$$\hat{\theta} = [\hat{L}_d \quad \hat{L}_q \quad \hat{\Psi}_m]^T \quad (9)$$

Rearranging (1), one can obtain the output and the regressor vectors for the case identification study as follows:

$$Y = \begin{bmatrix} V_d^* - RI_d \\ V_q^* - RI_q \end{bmatrix} \quad (10)$$

$$\varnothing = \begin{bmatrix} \dot{I}_d & -w_e I_q & 0 \\ w_e I_d & \dot{I}_q & w_e \end{bmatrix} \quad (11)$$

where  $\dot{I}_d$  and  $\dot{I}_q$  denotes for the derivative expressions of dq-axis currents which can be expressed by Euler approximation as  $(I_d(n+1) - I_d(n))T_s^{-1}$  and  $(I_q(n+1) - I_q(n))T_s^{-1}$ , respectively, where  $T_s$  is the sampling time. Then the updating algorithm is applied via (5)-(7) as illustrated in Fig. 3 to recursively estimate the nonlinear parameters by weighted least square cost functions.

### 4.3. Coefficient tuning and estimator initialization

$\lambda$  is the only coefficient that needs to be tuned in parameter estimation process. It is also known as the weighting coefficient as it weights the old data in the estimation. Theoretically,  $\lambda$  is tuned between zero and one, where one means the oldest measurements are equally weighted. Thus, the influence of the new measurement data reduces when  $\lambda$  approaches to one and hence the estimation process is relatively slow. On the contrary, the weight of the oldest measurements reduces when  $\lambda$  approaches

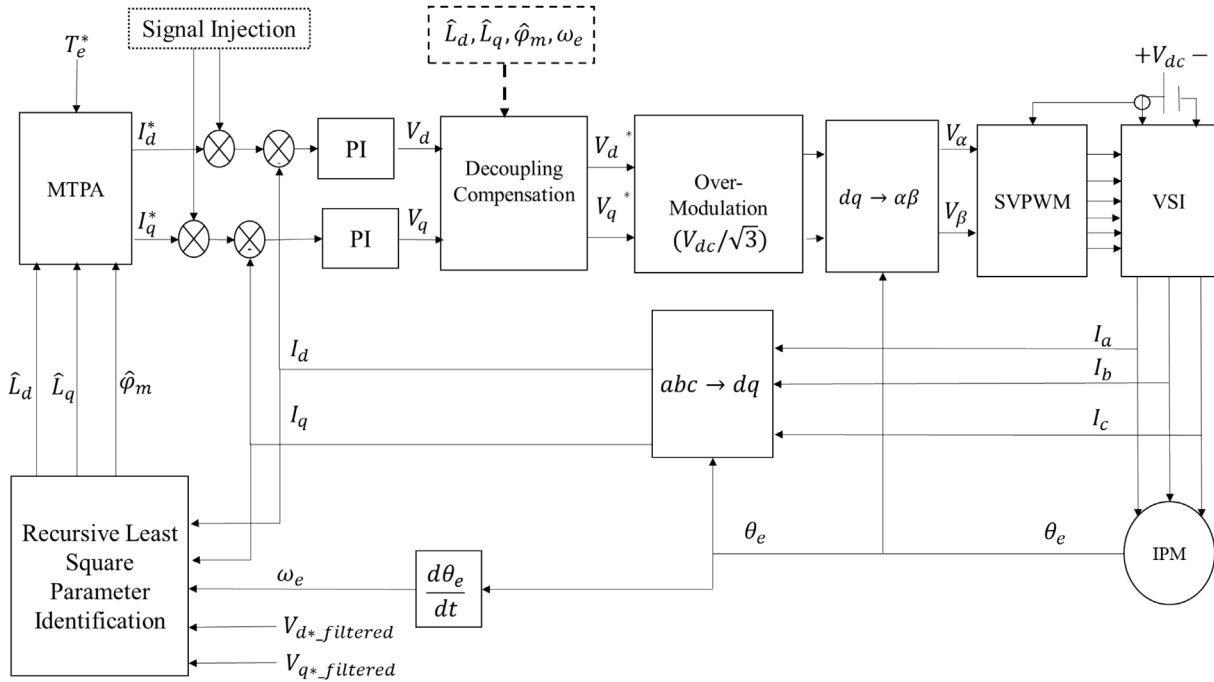

Fig. 2. Schematic of the proposed drive system.

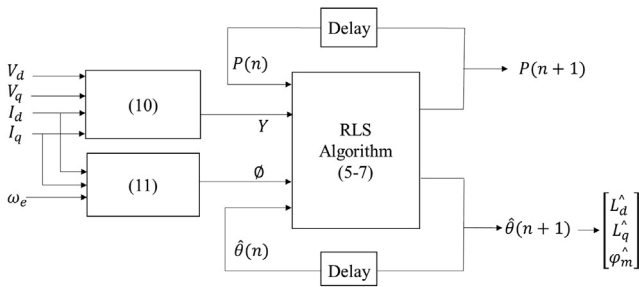

Fig. 3. Schematic of the RLS based parameter identification in proposed drive.

to zero and the influence of the new measurement data increases but the results may significantly fluctuate.

$\lambda \rightarrow 0$  : Fast response but estimated parameters fluctuate.

$\lambda \rightarrow 1$  : Estimated parameters become smooth but slow response.

Considering the above,  $\lambda$  is tuned based on the trade-off between fast response and smooth estimation process. It is noteworthy that sufficient response time is obtained with  $\lambda$  close to one [16].

In general, as a common solution for estimator initialization where initial conditions are not available, the process can start with the null parameter vectors and the identity covariance matrix. In the proposed drive, however, null parameter vector cannot be used due to zero divisions issue in MTPA block shown in Fig. 2. Thus, nonzero elements close to zero can be employed as initial condition of  $\theta$ . The initial covariance is  $P(0) = I$  where  $I$  is the 3\*3 identity matrix. The issues pertinent to rank deficiency is sorted out by injecting a high frequency small current signal into dq- axis current commands and its details can be found in [27].

## 5. Validation of the proposed drive

The effectiveness and superiority of the proposed strategy is validated by extensive realistic simulations of a 4.1 kW prototype

machine (Fig. 4 designed and manufactured for research and development in electric vehicle traction applications and the results are discussed in detail. Machine specifications are listed in Table 1.

The actual machine parameters in the drives have been deliberately altered by simulating the parameter nonlinearities as in [5,28]. Inverter switching frequency is set to 5 kHz and initial conditions of the parameters are  $10^{-6}$ . Nominal machine parameters can also be applied as initial condition of parameter vector, however, as a matter of fact this has negligible influence on the results.

As has been discussed,  $\lambda$  is the only coefficient that needs to be tuned in parameter estimation process and its influence on the proposed drive system has been studied. Step change to electromagnetic torque command from 5 Nm to 10 Nm has been applied to the drive at 0.25 s while the machine operates at 1000 rpm mechanical speed and resultant tuning influence of the forgetting factor on parameter estimation is shown in Fig. 5. As can be seen, there is a trade-off between fast response and smooth estimation process when tuning  $\lambda$ . It is seen from Fig. 5 that the forgetting factor  $\lambda = 0.999$  achieves adequate response time with smooth estimations. Hence, the forgetting factor is tuned as  $\lambda = 0.999$  in the rest of the paper. Steady-state and transient state improvements are validated in Sections 5.1 and 5.2, respectively.

### 5.1. Validation of the robustness to parameter variations

Conventional drive, where constant machine parameters are adopted in the controller, and the proposed drive, where parameter variations are handled online in the controller, have been operated at 1000 rpm mechanical speed while the torque is increased from no-load to full-load operation point. The results are illustrated in Fig. 6. It is evident that the precise torque control cannot be achieved in conventional drive when actual machine parameters deviate from those employed in the controller. However, when the parameter variations can be accurately estimated, the exact torque command can be produced by the machine in the proposed drive. Since parameter variations are handled online and employed in the controller, precise torque control has been achieved. As can be seen, when machine parameters vary with the MTPA trajectory

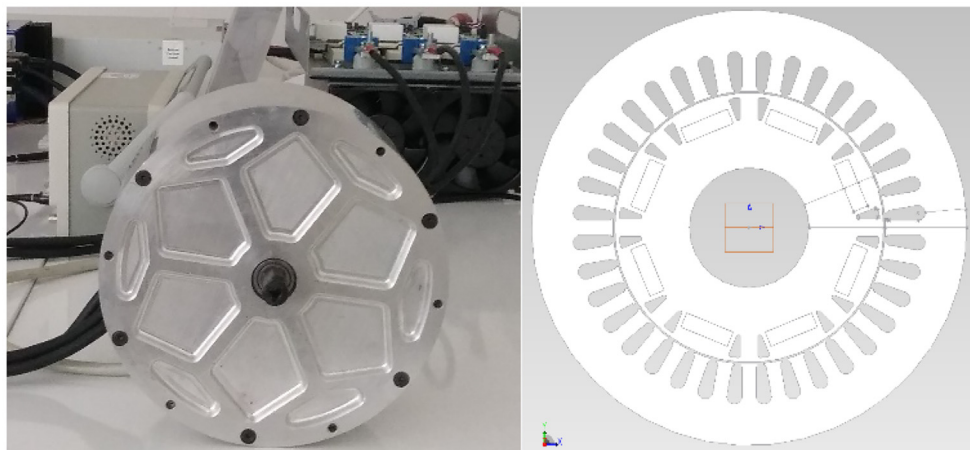

Fig. 4. Prototype IPM machine and its cross-section model (36-slot, 8-pole).

Table 1  
Prototype machine specifications.

Type	IPM	
Number of phase / poles	3 / 8	
Nominal Speed	2500 RPM	@120 V DC
Continuous Torque	15.7 Nm	@51.6 Arms
Continuous Power	4.1 kW	@120 V DC
Nominal dq- Axis Inductances	0.282 mH / 0.827mH	
Nominal PM Flux Linkage	0.0182 Wb	
Nominal Phase Resistance	0.0463 Ω	
Inertia	0.0072 kgm <sup>2</sup>	

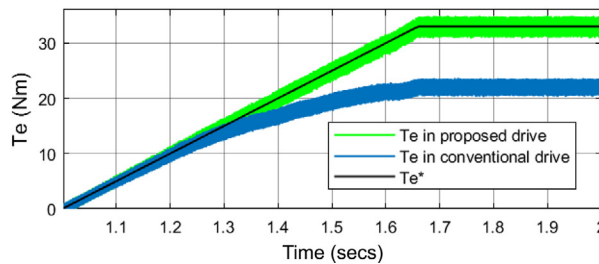
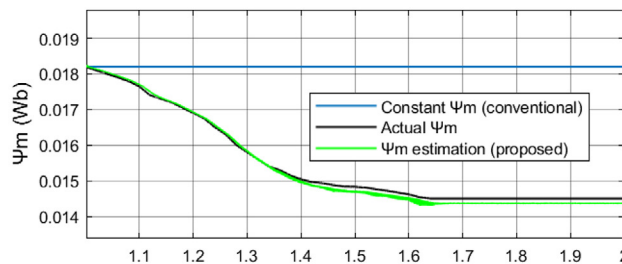
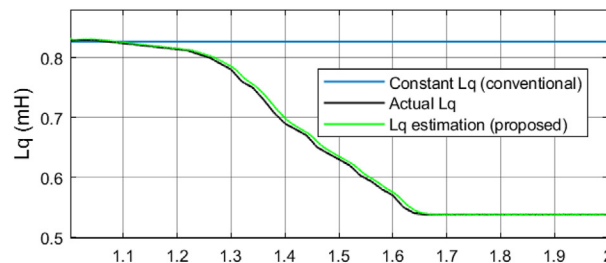
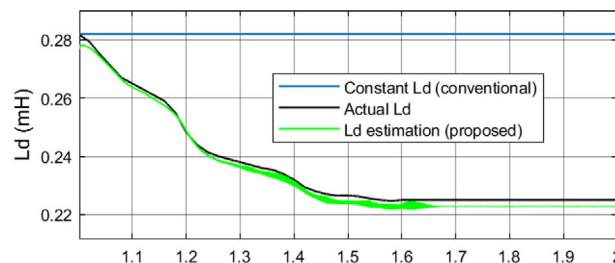

Fig. 6. Performance improvement validation at constant speed, varying torque operation.

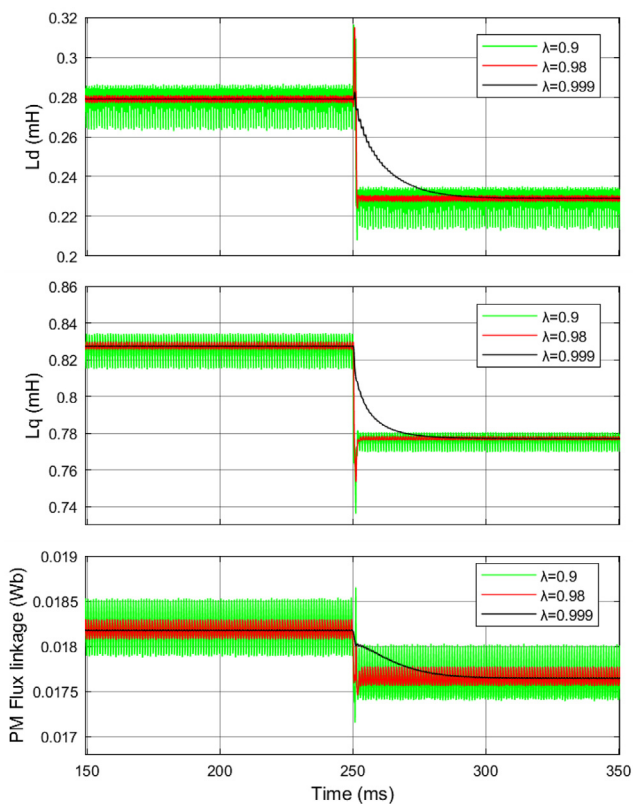

Fig. 5. Tuning influence of the forgetting factor on parameter estimation.

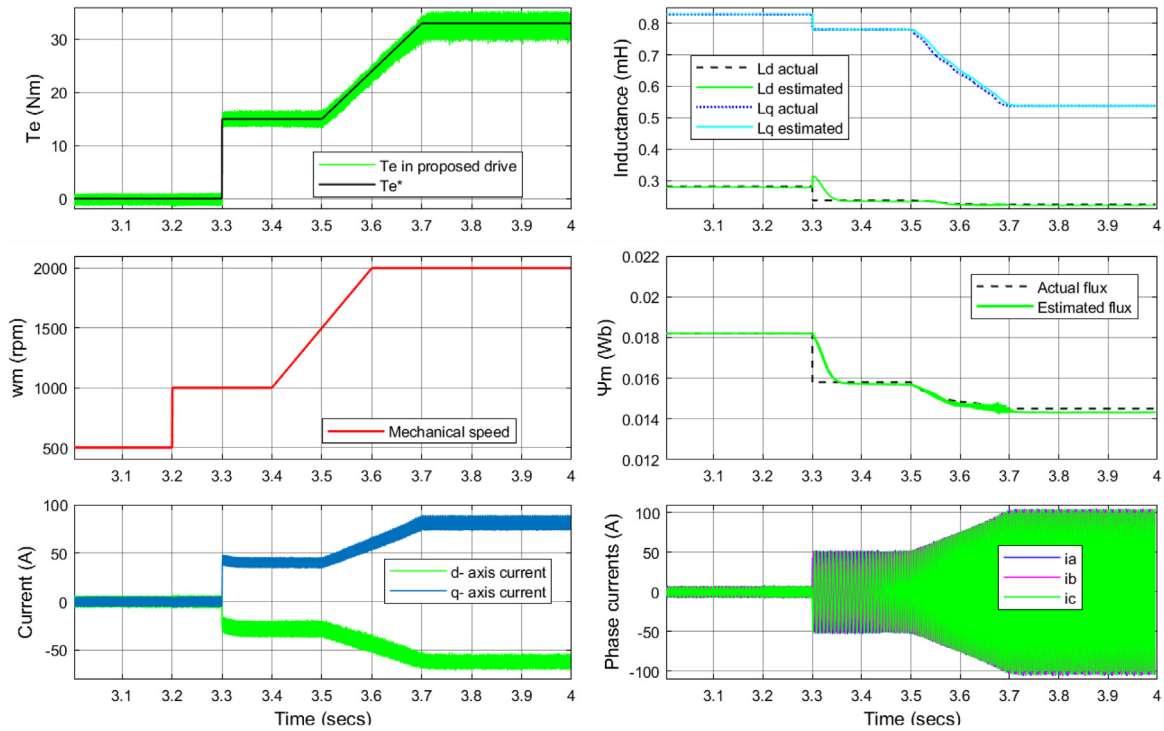

Fig. 7. Validation of the proposed drive at varying speed and varying torque operation.

as in real-life experiments, the drives where constant machine parameters are adopted cannot achieve accurate torque production and the produced torque may be  $\sim 28,7\%$  lower than the demanded peak torque.

The proposed drive has also been validated at varying load and varying speed conditions, representing both step and ramp changes as shown in Fig. 7. As can be seen, the drive is robust to parameter variations and the precise torque control has been achieved at wide range from no-load to peak torque at varying speeds. While step changes in torque and speed is not possible in real-life operations, it is evident in Fig. 7 that the proposed drive is robust to even step changes in torque and speed. Although the step changes in machine parameters are not possible in practice, the proposed estimation strategy identifies the sudden changes of the parameters with fast response (in milliseconds). It is noteworthy that the response time of the estimations in Fig. 7 can be improved by reducing the value of forgetting factor considering the trade-off in Fig. 5.

### 5.2. Decoupling compensation

The coupling terms in (1) may deteriorate the transient performance of the drive system unless decoupling compensation is employed. It is evident in (1) and (2) that decoupling compensation relies on accurate knowledge of machine parameters. The estimated parameters have been employed in decoupling compensation as shown in Fig. 2. Torque command has been decreased from 15Nm to 10Nm step change at 0.2 s when machine operates at 2500 rpm and the PI controllers in Fig. 2 has been tuned as in [29]. To better illustrate the influence of decoupling compensation on dynamic performance of the system, the modulation strategy and the power electronics blocks have been deliberately removed in the simulated drive. Improved dynamic performance in the proposed drive has been validated in Fig. 8.

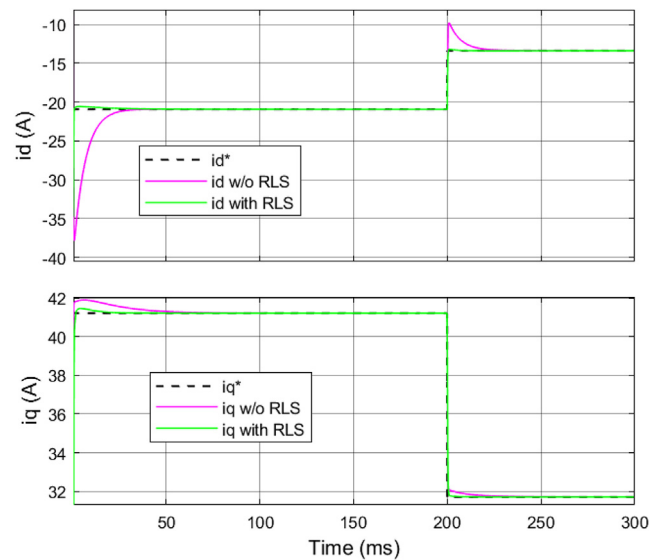

Fig. 8. Transient-state performance improvement validation with proposed compensation strategy.

## 6. Conclusion

The issues pertinent to state-of-art drives have been discussed in detail and a novel IPM machine drive has been proposed in this paper. Nonlinear machine parameters (dq- axis inductances and permanent magnet flux linkage) have been estimated online through recursive least squares algorithm with fairly high accuracies of each and the estimated parameters have been employed in the controller to achieve precise torque control and to improve decoupling compensation. Implementation and initialization strategy of the proposed technique with coefficient tuning has been

analysed and discussed. Nonlinear machine models have been employed in the simulated drives as in real life experiments and 28.7% Nm higher output torque have been achieved at the full-load torque operation compared to the drive where constant machine parameters are employed in the controller. The effectiveness and the superiority of the proposed drive has been validated through high-fidelity machine models of a 4.1 kW prototype IPM machine designed and manufactured for research and development in electric vehicle traction applications.

### Declaration of Competing Interest

The authors declare that they have no known competing financial interests or personal relationships that could have appeared to influence the work reported in this paper.

### Acknowledgements

This study has been supported by the Scientific and Technological Research Council of Turkey (TUBITAK) through the Scientific and Technological Research Projects Funding Program (1001) with a project numbered as 118E858.

### References

- [1] S. Turkdogan, Design and optimization of a solely renewable based hybrid energy system for residential electrical load and fuel cell electric vehicle, *Eng. Sci. Technol., Int. J.* 24 (2) (2021) 397–404.
- [2] M.U. Cuma, Ç.D. Ünal, M.M. Savrun, Design and implementation of algorithms for one pedal driving in electric buses, *Eng. Sci. Technol., Int. J.* 24 (1) (2021) 138–144.
- [3] C. Chellaswamy, L. Balaji, T. Kaliraja, Renewable energy based automatic recharging mechanism for full electric vehicle, *Eng. Sci. Technol., Int. J.* 23 (3) (2020) 555–564.
- [4] M. Koç, S. Emiroğlu, B. Tamyürek, Analysis and simulation of efficiency optimized IPM drives in constant torque region with reduced computational burden, *Turk. J. Electric. Eng. Comput. Sci.* 29 (3) (2021) 1643–1658.
- [5] X. Chen, J. Wang, B. Sen, P. Lazari, T. Sun, A high-fidelity and computationally efficient model for interior permanent-magnet machines considering the magnetic saturation, spatial harmonics, and iron loss effect, *IEEE Trans. Ind. Electron.* 62 (7) (2015) 4044–4055.
- [6] H. Patel, H. Chandwani, Simulation and experimental verification of modified sinusoidal pulse width modulation technique for torque ripple attenuation in Brushless DC motor drive, *Eng. Sci. Technol., Int. J.* 24 (3) (2021) 671–681.
- [7] M.S. Rifaq, J.-W. Jung, A comprehensive review of state-of-the-art parameter estimation techniques for permanent magnet synchronous motors in wide speed range, *IEEE Trans. Ind. Inf.* 16 (7) (2020) 4747–4758.
- [8] Z.Q. Zhu, D. Liang, K. Liu, Online parameter estimation for permanent magnet synchronous machines: an overview, *IEEE Access* 9 (2021) 59059–59084.
- [9] N. Jin, Q. Zhu, Z. Zhang, Y. Zhou, MTPA trajectory tracking control for interior PMSM based on adaptive parameter identification, *Int. J. Control Automation* 9 (4) (2016) 395–404.
- [10] I. Vesely, L. Vesely, Z. Bradac, MRAS identification of permanent magnet synchronous motor parameters, *IFAC-PapersOnLine* 51 (6) (2018) 250–255.
- [11] O.C. Kivanc, S.B. Ozturk, Sensorless PMSM drive based on stator feedforward voltage estimation improved With MRAS multiparameter estimation, *IEEE/ASME Trans. Mechatron.* 23 (3) (2018) 1326–1337.
- [12] X. Li, R. Kennel, General Formulation of Kalman-Filter-Based Online Parameter Identification Methods for VSI-Fed PMSM, *IEEE Trans. Ind. Electron.* 68 (4) (2021) 2856–2864.
- [13] S.-Y. Cho, W.-G. Shin, J.-S. Park, W.-H. Kim, A torque compensation control scheme of PMSM considering wide variation of permanent magnet temperature, *IEEE Trans. Magn.* 55 (2) (2019) 1–5.
- [14] S. Kim et al., Torque ripple improvement for interior permanent magnet synchronous motor considering parameters with magnetic saturation, *IEEE Trans. Magn.* 45 (10) (2009) 4720–4723.
- [15] Y. Inoue, Y. Kawaguchi, S. Morimoto, M. Sanada, Performance Improvement of Sensorless IPMSM Drives in a Low-Speed Region Using Online Parameter Identification, *IEEE Trans. Ind. Appl.* 47 (2) (2011) 798–804.
- [16] F. Tinazzi, P.G. Carlet, S. Bolognani, M. Zigliotto, Motor parameter-free predictive current control of synchronous motors by recursive least-square self-commissioning model, *IEEE Trans. Ind. Electron.* 67 (11) (2020) 9093–9100.
- [17] X. Ma, C. Bi, A technology for online parameter identification of permanent magnet synchronous motor, *CES Trans. Electric. Mach. Syst.* 4 (3) (2020) 237–242.
- [18] A. Piippo, M. Hinkkanen, J. Luomi, Adaptation of Motor Parameters in Sensorless PMSM Drives, *IEEE Trans. Ind. Appl.* 45 (1) (2009) 203–212.
- [19] A. Brosch, S. Hanke, O. Wallscheid, J. Bocker, Data-driven recursive least squares estimation for model predictive current control of permanent magnet synchronous motors, *IEEE Trans. Power Electron.* 36 (2) (2021) 2179–2190.
- [20] W. Xu, R.D. Lorenz, High-frequency injection-based stator flux linkage and torque estimation for DB-DTFC implementation on IPMSMs considering cross-saturation effects, *IEEE Trans. Ind. Appl.* 50 (6) (2014) 3805–3815.
- [21] S.J. Underwood, I. Husain, Online parameter estimation and adaptive control of permanent-magnet synchronous machines, *IEEE Trans. Ind. Electron.* 57 (7) (2010) 2435–2443.
- [22] Y.-C. Kwon, S. Kim, S.-K. Sul, Six-step operation of PMSM with instantaneous current control, *Ind. Appl., IEEE Trans.* 50 (4) (2014) 2614–2625.
- [23] G. Feng, C. Lai, N.C. Kar, A novel current injection-based online parameter estimation method for PMSMs considering magnetic saturation, *IEEE Trans. Magn.* 52 (7) (2016) 1–4.
- [24] G. Feng, C. Lai, K. Mukherjee, N.C. Kar, Current injection-based online parameter and VSI nonlinearity estimation for PMSM drives using current and voltage DC components, *IEEE Trans. Transp. Electr.* 2 (2) (2016) 119–128.
- [25] T. Sun, M. Koc, J. Wang, MTPA control of IPMSM drives based on virtual signal injection considering machine parameter variations, *IEEE Trans. Ind. Electron.* 65 (8) (2018) 6089–6098.
- [26] M. Koç, Efficiency Optimised Control of Interior Mounted Permanent Magnet Machines for Electric Vehicle Traction eThesis Online, in: *Electronic and Electrical Engineering*, The University of Sheffield, White Rose, 2016, p. 219.
- [27] S. Nalakath, M. Preindl, A. Emadi, Online multi-parameter estimation of interior permanent magnet motor drives with finite control set model predictive control, *IET Electr. Power Appl.* 11 (2017) 944–951.
- [28] X. Chen, J. Wang, A. Griffo, A high-fidelity and computationally efficient electrothermally coupled model for interior permanent-magnet machines in electric vehicle traction applications, *IEEE Trans. Transp. Electr.* 1 (4) (2015) 336–347.
- [29] S.-H. Kim, Chapter 6 - Current regulators of alternating current motors, in: S.-H. Kim (Ed.), *Electric Motor Control*, Elsevier, 2017, pp. 247–264.